

48" Precast Concrete Closed Riser Tread

HANDCRAFTED

Diamond's precast products are engineered, handcrafted and manufactured in a controlled environment which ensures our consistent high-quality, uniformity of style and function, and the precise fit you need for your design and build projects.

SAVES TIME AND LABOR

Diamond's precast products arrive ready and easy for you to install at your site, eliminating the risk and delays of on-site pouring, finishing and curing. This greatly reduces jobsite disruption, saving significant time and labor costs for you and your customers.

SUSTAINABLE

Diamond's durable precast concrete products are cast in reusable molds, do not decompose or emit any toxic fumes, gasses or harmful components and require little need for repair or maintenance over their long lifetime, making them ideal for both hot and cold climates. In addition, we strive to maintain this lower environmental impact by using only local resources for all our concrete production, thus further reducing our footprint for the absolute green alternative.



Available Finishes

- Standard Broom
- Exposed Aggregate
- 2" Aggregate Strip
- 4-Line Trowel Strip
- Aluminum Nosings
- Sandblast
- Polished
- Davis Concrete Colors
- Smooth Trowel
- Concrete Sealant

SPRAYLOCK Concrete Protection

A sustainable concrete building process includes energy reduction, material use stewardship, and the need for less expense and upkeep efforts. That's why all Diamond products are manufactured using Spray-Lock's Amorfa concrete additive. Amorfa reduces permeability while enhancing the overall characteristics of our mix design and results in greater UHPC-level durability, attack resistance, less maintenance, efflorescence protection, better appearance and a longer product lifecycle for a more sustainable and worry-free precast concrete product solution.

Customer Support

Known for our long history of workmanship, attention to detail and pride in our products, the Diamond Design Precast team is here to provide you with superior customer service and support for all your project needs. From the time you order to when you receive your final product ready for install, we are with you every step of the way!



*All of our treads are install-ready and come with a standard broom finish and include galvanized or steel brackets, hex bolts and lag bolts.

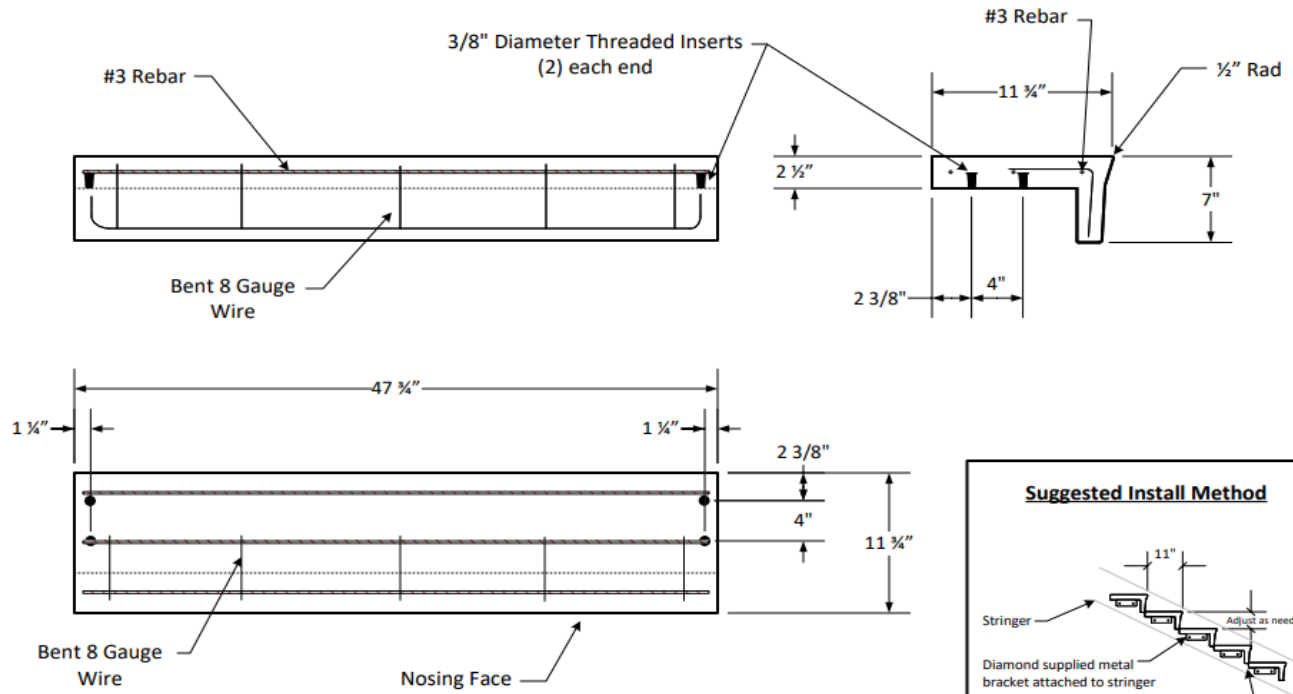

Suggested Install Method

Stringer

Diamond supplied metal bracket attached to stringer

Adjust as needed

Installation of treads should be laid out so that the riser falls behind the tread below to allow for height adjustment as needed

Approval Signature: _____ Date: _____

Do Not Scale

Product:	48" Closed Riser Tread	Finish:	Broom	Qty:	
Job Name:		Sales Order:		Drawn By: TR	Date: 10/18/22

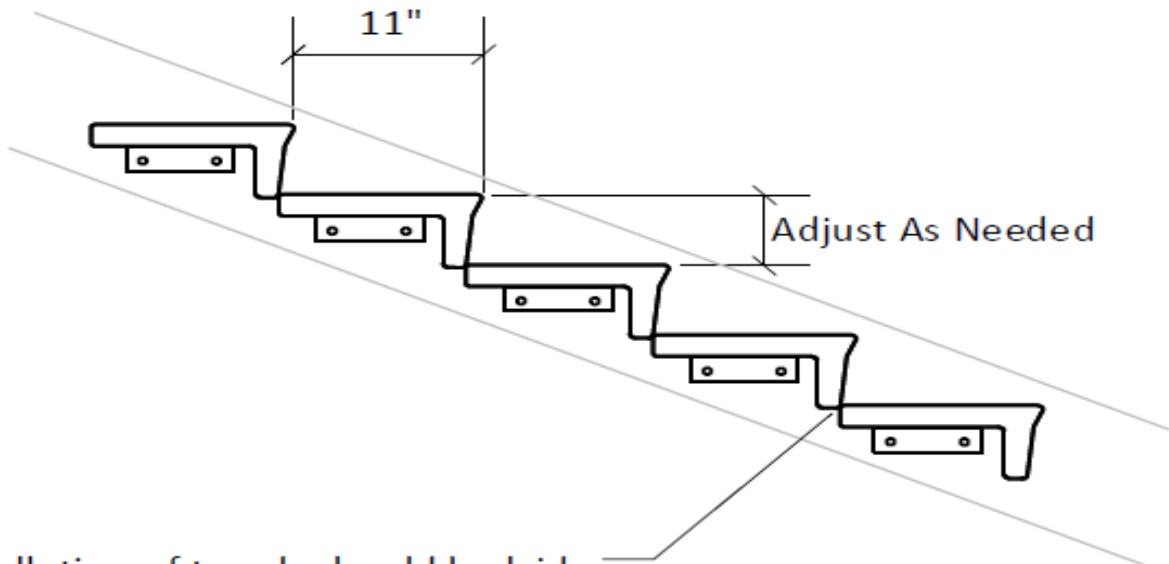

Installation of treads should be laid out so that the riser falls behind the tread below to allow for height adjustment as needed.